

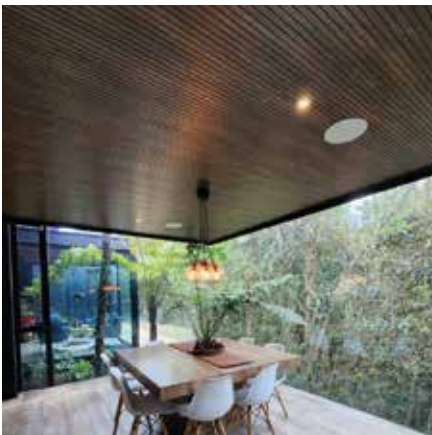

Liscio interior reference

Coating for interior spaces in WPC material (Wood and Plastic Compound) with great benefits as it doesn't need maintenance, resistant to weather changes and easy installation process..



COATING FOR INTERIORS

LUZO

BUILDING MATERIALS



WEATHER CHANGES



PLAGUES RESISTANT



SLOW COMBUSTION

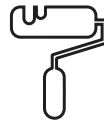

CAN BE PAINTED



ECOFRIENDLY



EASY AND FAST INSTALLATION



HUMIDITY RESISTANT



CORROSION RESISTANT

USES AND APPLICATIONS

· Applications on interior spaces

- Interiorism
- Ceilings
- Coatings

CHARACTERISTICS.



3D WALL PANEL	
Wide:	9-7/8"
Lenght:	9'-6"
Depth:	3/8"
Finish:	Corrugated
Weight:	6lb / unit
Composition:	Encapsulated WPC

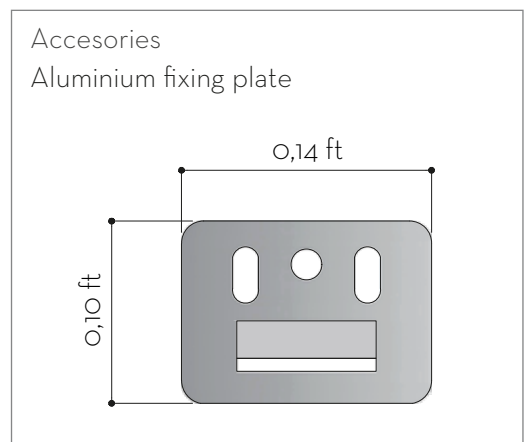
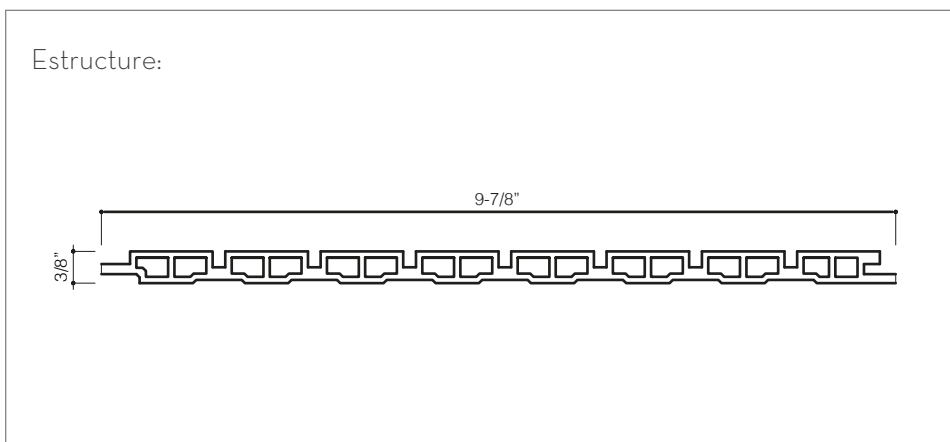
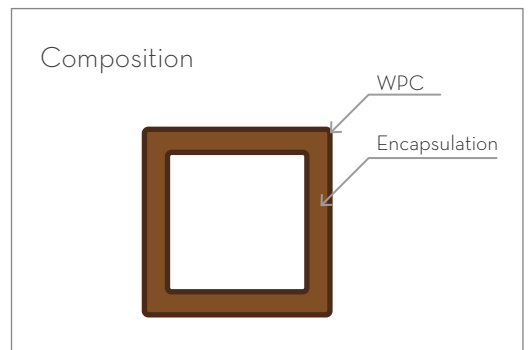

COLORS:



Ebony



Ashen



Hue

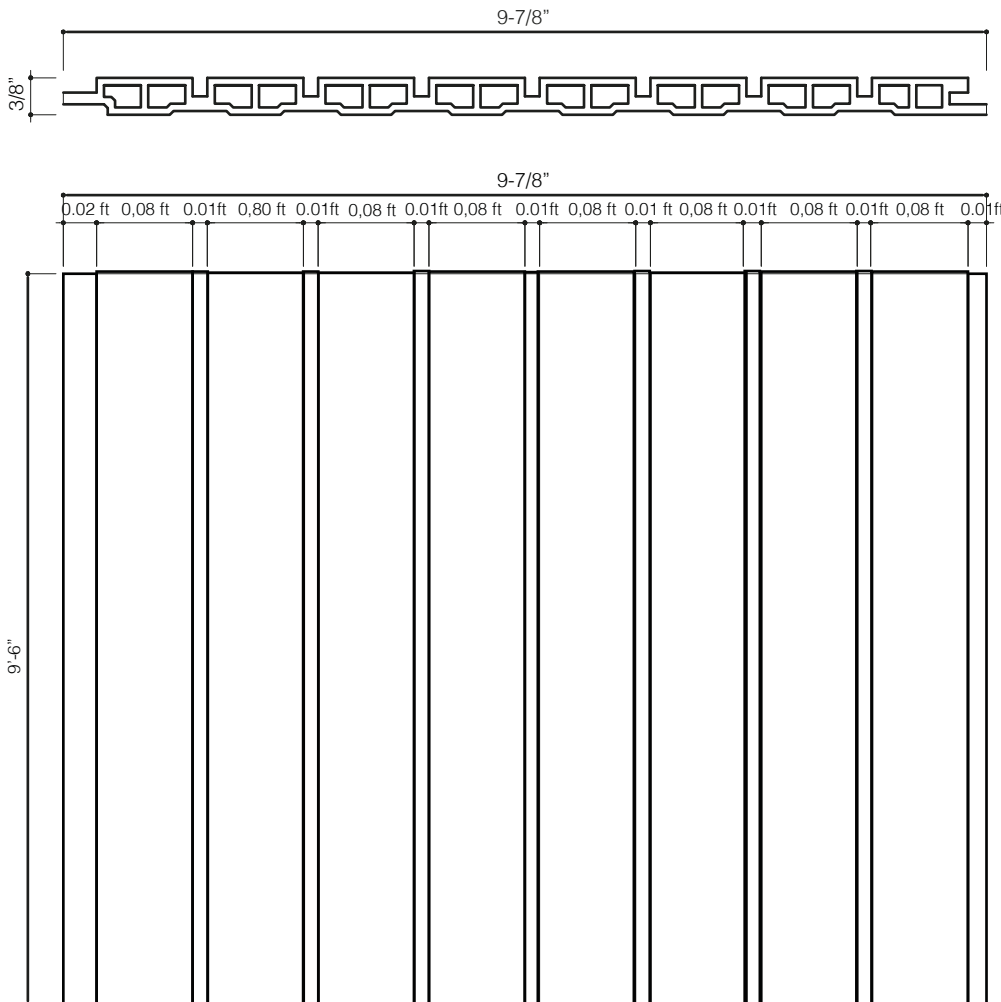

LONG / 9'-6"

WIDTH / 9-7/8"

DEPTH / 3/8"

MAINTENANCE AND USAGE RECOMENDATIONS:

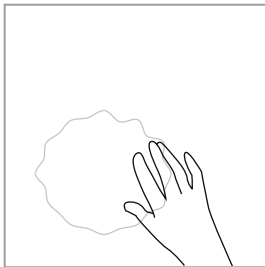

Clean the panel with an humid or dry cloth.



Do not use agressive cleaning products. May discolor panels.

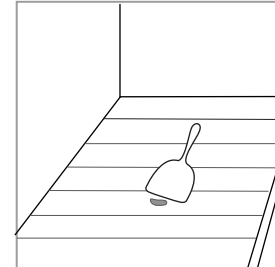

Attached products must be removed with a plastic spatula.



While putting the material on the floor do not hit it, be careful during all the transport process.

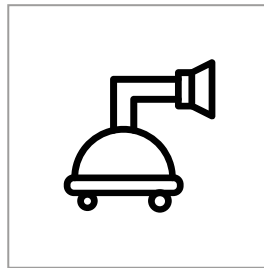

It can be washed with pressurized water, 1100PSI as it maximum recomended. Always use the safety measures and prevent any possible damage.

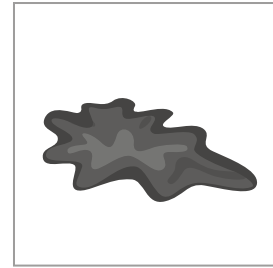

If any contamination appears clean it inmediatly and completely washing of the sustance. If it's abrasive dry it, DO NOT rub it, then soak with hot water and dry again with a soft cloth.

WARRANTY

LUZZO BM guarantees the quality, suitability, efficiency and safety of the products it offer and supply, as long as the appropriate parameters, recommendations and suggestions for use, handling, installation and maintenance are met as informed in the content of the technical sheets prepared and by the advisors. Information about our products is accurate to the best of our knowledge. However, it should be considered only as a suggestion since each consumer must make their own designs, measurements and installation according to the specific use for which the products are required. Non-compliance with the installation, maintenance and use specifications generates the non-application of the guarantee.