

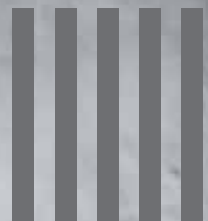

Laminates  
& Things

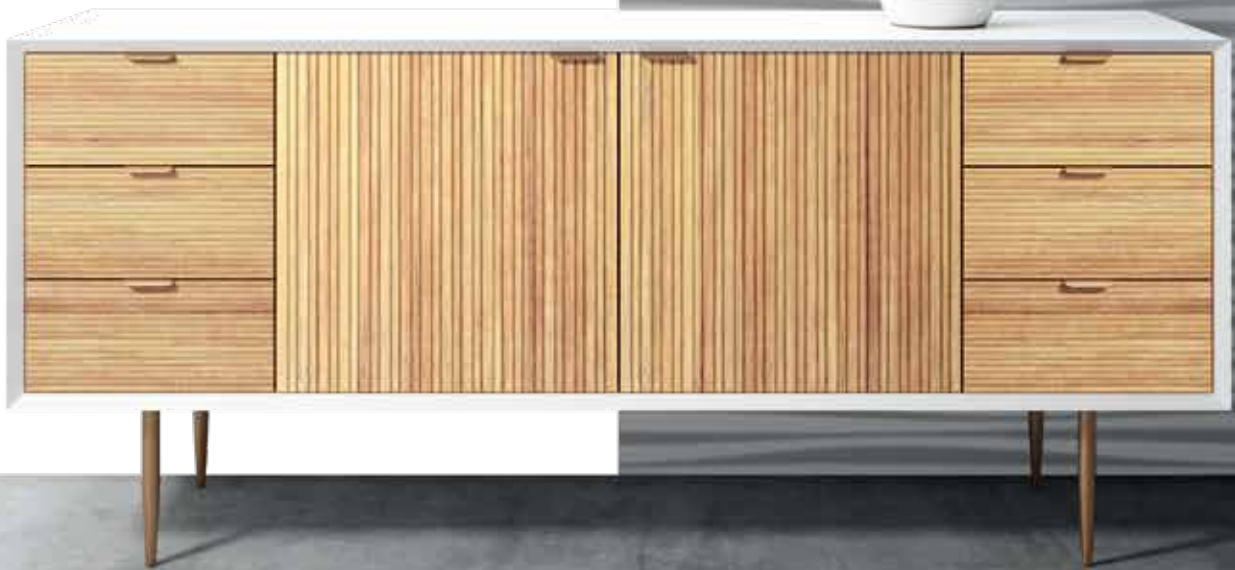

3D  
PANEL





# What is 3D PANEL?

3D Panel is our newest innovative solution for premium interior furniture. MDF is first laminated with a foam layer. Then, foam laminated MDF is covered with the desired foil. As the last step, pressure is applied on the panel to give it the desired 3D design.

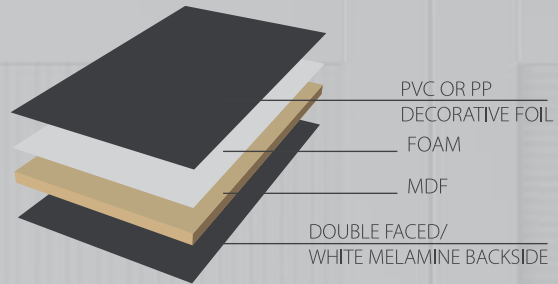

**DOUBLE FACED/  
WHITE MELAMINE  
BACKSIDE**

PANEL DIMENSIONS	
Width	1220mm
Length	2800mm
Thickness	18/10mm

\*thickness options available

## COLOR & DECORS

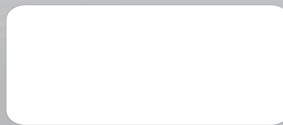

S010 | S.M. White



S027 | S.M. Mink

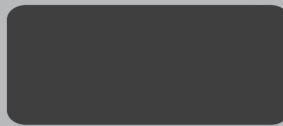

S036 | S.M. Dark Grey



S038 | S.M. Dust Grey

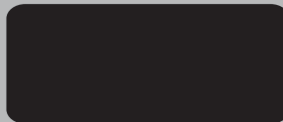

S040 | S.M. Black



4040 | Silver



A360 | P. Teak

# 6 Design Options

available in MATT & SUPERMATT



3D01

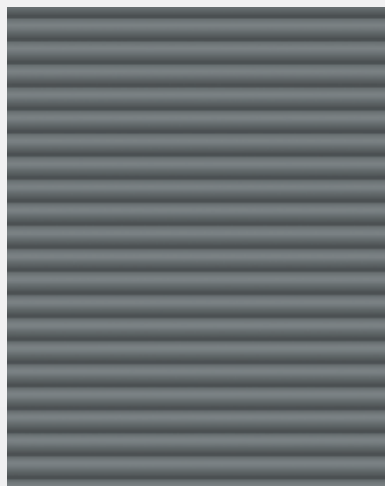
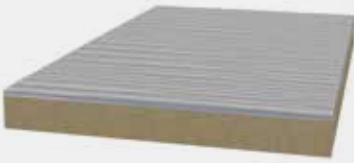

3D02

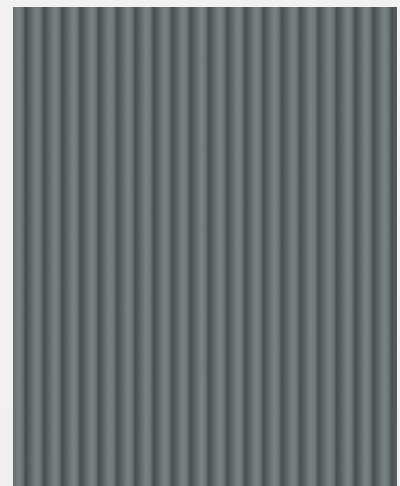

3D03



3D04

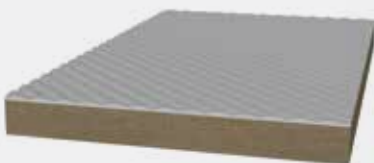

3D05

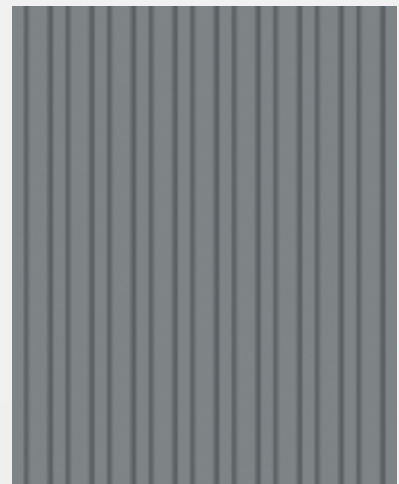
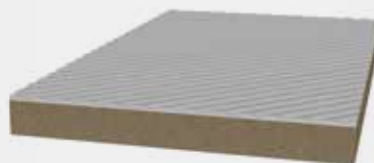

3D06



\*Custom designs can be made upon request.

# How to FINISH THE SIDES?

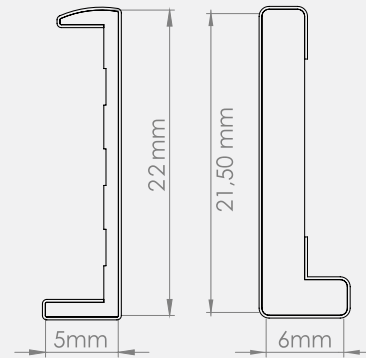
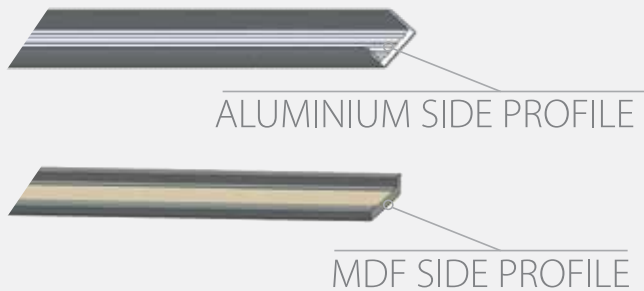

SIDE PROFILES (mm)	
Length	2800
Width	22 / 21,5

Instead of regular edgebanding, aluminium or MDF edge profiles of same color & foil are used to achieve a cleaner & more elegant look. Accessories can be applied by using PU transparent mounting adhesive in the applications of aluminium edge profiles.

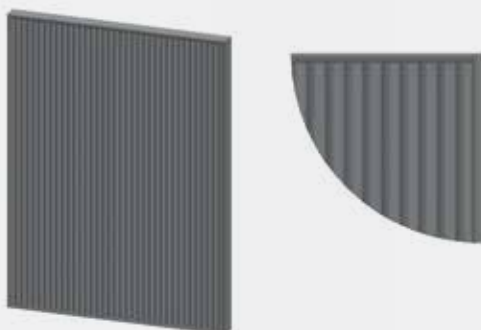
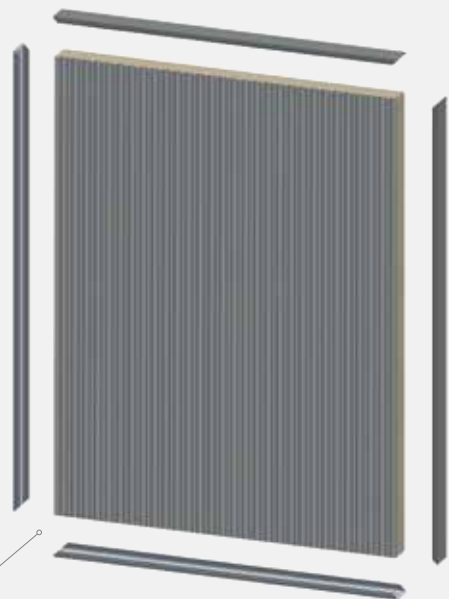

If aluminium edge profiles are going to be used for all 4 sides, they should be cut in a 45° angle.

\*Custom designs can be made upon request.





## TECHNICAL INFORMATIONS

No	FEATURE	VALUE	RESULT (Super matt)	STANDART
1	Gloss level (60° angle)	-	5 GU	TS EN 14323
2	Scratch resistance	H	3H	TS 7385
3	Assessment of surface resistance to wet heat (85°C)	5	5 (No change)	TS EN 12721+A1:2014:02
4	Assessment of surface resistance to dry heat (70°C)	5	5 (No change)	TS EN 12722+A1:2014:02
5	Surface abrasion resistance	5	250 rev. (Class 4)	TS EN 14323 : 2021-12 6.9
6	Behavior towards impact loading by falling steel ball	5	2 (There is change)	TS EN 14323:2021-12 6.13
7	Test of water steam resistance	5	2 (There is change)	TS EN 14323:2021-21,Art. 6.10
8	Resistance to staining	5	5 (No change)	TS EN 14323 6.6
9	Assessment of surface resistance to chemical cold liquids (Acetic acid, acetone, ammonia solution, citric acid, cleaning agent, etc.)	5	5 (No change)	TS EN 12720:2009+A1:2014-02
10	Colorfastness to light	5	5. Grade	TS EN 15187
11	Thickness tolerance	-	± 0,30 mm	TS EN 324-1
12	Bow tolerance	-	3,5 mm / m	Gizir
13	Width and Length tolerance	-	± 5 mm / m	TS EN 324-1

- These values are weighted average of the test results.

- The test results of the 6th and 7th tests became the 2nd level out of the 5th level according to the product standard determined by TSE.



### HEADQUARTERS

1596 West 34th Place  
Hialeah, Florida 33012

Contact us: +1 (305) 362-8080  
www.laminatesandthings.com

